

Vaccine Storage and Handling Toolkit

National Center for Immunization and Respiratory Diseases

Storage Troubleshooting

Handling Inappropriate Vaccine Storage Conditions (Light and Temperature)

⚠ Immediate action must be taken to correct improper vaccine storage conditions, including inappropriate exposure to light and inappropriate exposure to storage temperatures outside the recommended ranges.

Temperature Log for Vaccines (Fahrenheit)

Month/Year: January 18, 2008 Days 1-15

***Instructions:** Place an "X" in the box that corresponds with the temperature. The hatched zones represent unacceptable temperature ranges. If the temperature recorded is in the hatched zone: 1. **Store the vaccine** under proper conditions as quickly as possible. 2. **Call the vaccine manufacturer(s)** to determine whether the potency of the vaccine(s) has been affected. 3. **Call the immunization program at your local health department** for further assistance: (404) 555-8812, and 4. **Document the action** taken on the reverse side of this log.

Day of Month	1	2	3	4	5	6	7	8	9	10	11	12	13	14	15
Exact Time	8:00	8:00	8:00	7:05	7:05	7:05	7:05	7:05	7:05	7:05	7:05	7:05	7:05	7:05	7:05
T Temp	am : pm	am : pm	am : pm	am : pm	am : pm	am : pm	am : pm	am : pm	am : pm	am : pm	am : pm	am : pm	am : pm	am : pm	am : pm
Refrigerator temperature															
48°															
47°															
46°															
45°															
44°															
43°															
42°				X	X	X	X								
41°					X										
40°			X	X	X										
39°		X	X												
38°	X														
37°															
36°															
35°															
34°															
33°															
32°															
31°															
30°															
29°															
28°															
Freezer temp															
7°															
6°															
5°		X	X	X	X	X	X	X	X						
4°	X														
Room temp															
Staff Initials	(u) (u) (u)	(u) (u) (u)	(u) (u) (u)	(u) (u) (u)	(u) (u) (u)	(u) (u) (u)	(u) (u) (u)	(u) (u) (u)	(u) (u) (u)	(u) (u) (u)	(u) (u) (u)	(u) (u) (u)	(u) (u) (u)	(u) (u) (u)	(u) (u) (u)

Adapted by the Immunization Action Coalition courtesy of the Michigan Department of Community Health

www.immunize.org/catg.d/p3039.pdf • Item #P3039 (8/04)

Immunization Action Coalition • 1573 Selby Ave., Ste. 234 • St. Paul, MN 55104 • (651) 647-9009 • www.immunize.org • admin@immunize.org

⚠ Immediate action must be taken to correct improper vaccine storage conditions.

Furthermore, this action should be documented. In your documentation, state what the problem is, what has been done to protect the vaccines, what has been done to correct the problem, and whether or not the problem has been corrected. You may use the back of the temperature log to record this information. If you become aware of inappropriate vaccine storage conditions, the following steps should be taken:

1. Notify the primary or backup vaccine coordinator immediately of any vaccine storage unit temperatures that are outside the recommended range. If the primary coordinator or the backup person is not available, report the problem to an immediate supervisor.

2. Record the room temperature and the temperature inside the refrigerator and freezer at the time the problem is discovered. Also note the minimum and maximum temperature readings if you have minimum/maximum thermometers in the refrigerator and freezer. Record the length of time the vaccine may have been exposed to inappropriate storage temperatures.



Notify the primary or backup vaccine coordinator immediately of any vaccine storage unit temperatures that are outside the recommended range.

3. Conduct an inventory of the vaccines affected by this event and record the actions taken. Also note if water bottles were in the refrigerator and frozen packs in the freezer at the time of this event. You may use the [Emergency Response Worksheet](#) in the Resources section of this toolkit to help organize your response. Consult your agency, local health department, or state health department immunization program, as appropriate for your situation, for any special instructions or forms.

4. Isolate the affected vaccine vials or packages and mark them as "DO NOT USE." This will reduce risk of inadvertently using vaccine that may have lost its potency because it was stored under inappropriate conditions.

5. Store the potentially compromised vaccines under appropriate conditions in a properly functioning vaccine storage unit until the integrity of the vaccine is determined. If your vaccine storage unit is not maintaining the appropriate storage conditions, activate the [Emergency Vaccine Retrieval and Storage Plan](#) (see section on Storage and Handling Plans).



Isolate the affected vaccine vials or packages and mark them as "DO NOT USE."

6. Contact the vaccine manufacturer and the state health department immunization program for further guidance. Do not assume that vaccine inappropriately exposed to light or to excessive temperatures cannot be salvaged.

7. Finally, if HPV, MMR, MMRV, rotavirus, varicella, and/or zoster vaccines have been exposed to light, return the vaccine to a dark environment at the appropriate storage temperature and record the length of time the vaccine may have been exposed. Again, contact the vaccine manufacturer and the state health department immunization program for further guidance.

If vaccines have been exposed to inappropriate storage temperatures because of a fault in the refrigerator or freezer, follow the directions above and see [Handling Malfunctioning Vaccine Storage Units](#) in this section for further details.

Handling Malfunctioning Vaccine Storage Units

General Instructions

The vaccine storage unit is not working properly if any of the following situations occur:

- The vaccine storage unit is too warm.
- The vaccine storage unit is too cold.
- The vaccine storage unit is too noisy.
- The vaccine storage unit has stopped.

The most important step to take if the vaccine storage unit is not working properly is to protect the vaccine supply. Do not allow the vaccine to remain in a nonfunctioning unit for an extended period of time while you attempt to correct the problem.

If at any time you are unsure how long the storage unit will not be functioning properly or you determine that the problem cannot be corrected in time to maintain the internal temperature within the recommended range,

The most important step to take if the vaccine storage unit is not working properly is to protect the vaccine supply.

activate the Emergency Vaccine Retrieval and Storage Plan (see section on Storage and Handling Plans).

The problem-solving flow charts provided in this section may be used to identify and correct vaccine storage unit problems. Follow these instructions when using the problem-solving flow charts:

1. Record the room temperature and the temperatures inside the refrigerator and freezer when the problem is discovered. Also conduct an inventory of all vaccines affected by the event (see Handling Inappropriate Vaccine Storage Conditions [Light and Temperature] in this section).
2. Always start with the first problem shown in the problem-solving flow chart.
3. Make sure that a problem does not exist before moving on to the next step.
4. If the storage unit is still not working properly after completing all the steps in the flow chart,
 - a. call a technician to examine the faulty equipment; and
 - b. if you have not yet done so, transfer the vaccine into another functioning storage unit that has enough space to store the vaccines properly (see Emergency Vaccine Retrieval and Storage Plan in the Storage and Handling Plans section).
5. Record in the vaccine storage unit logbook all the checks you made and the actions taken (see Equipment Logbooks in the Vaccine Storage Equipment section for details). This will help the technician identify the fault with the storage unit.

Vaccine Storage Unit is Too Warm

Warning! Do not allow the vaccine to remain in a nonfunctioning unit for an extended period of time while you attempt to correct the problem. If at any time you are unsure how long the storage unit will not be functioning properly or you determine that the problem cannot be corrected in time to maintain the internal temperature within the recommended range, activate the [Emergency Vaccine Retrieval and Storage Plan](#) (see section on Storage and Handling Plans).

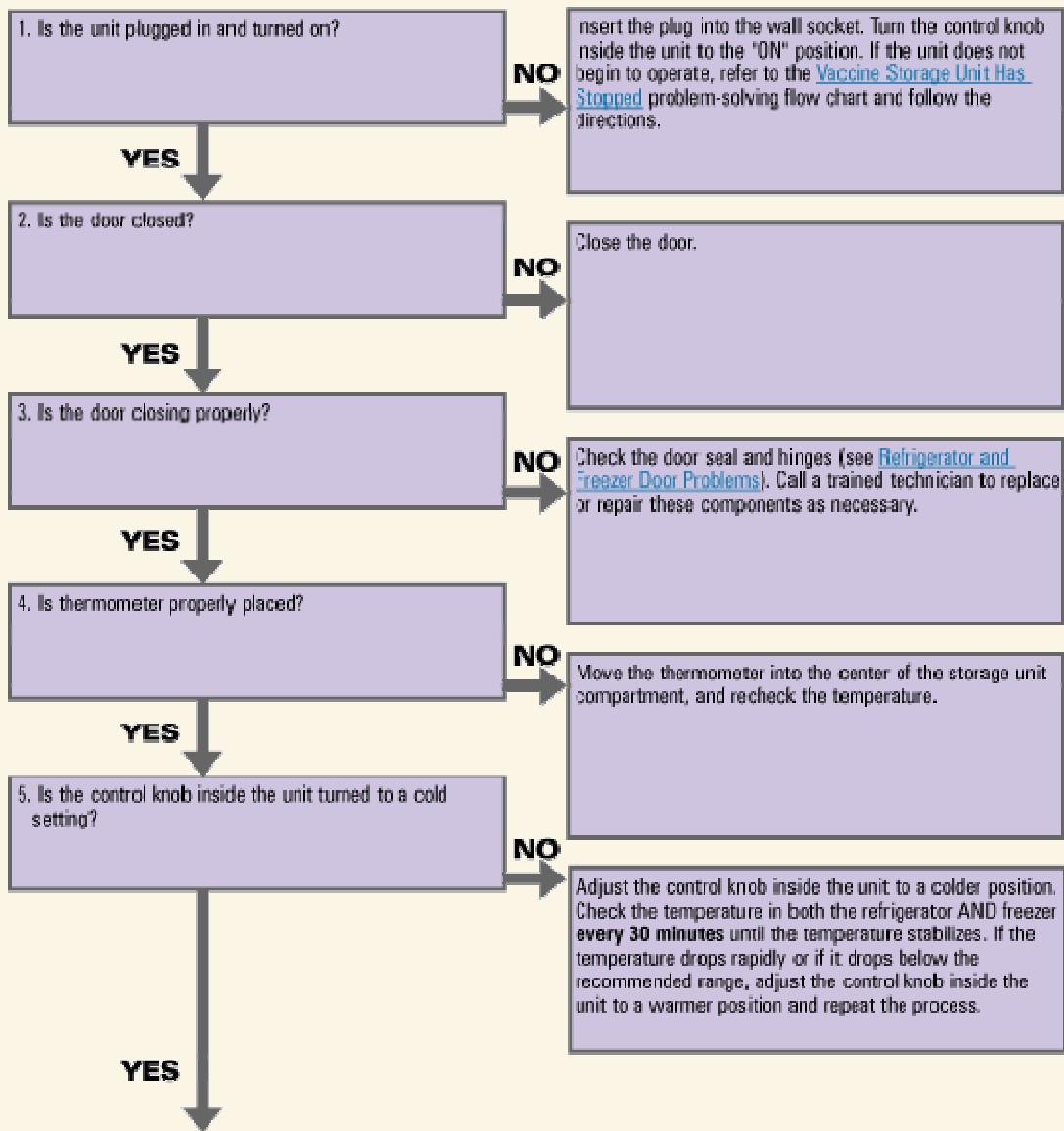

Vaccine Storage Unit is Too Warm cont'd

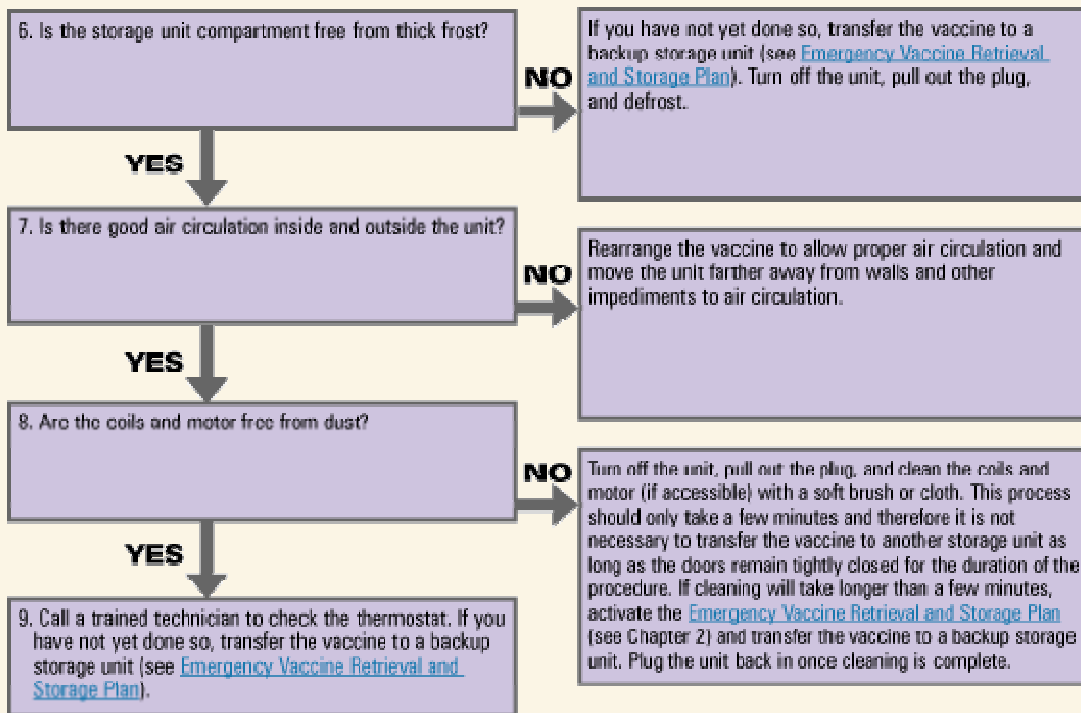

Vaccine Storage Unit is Too Cold

Warning! Do not allow the vaccine to remain in a nonfunctioning unit for an extended period of time while you attempt to correct the problem. If at any time you are unsure how long the storage unit will not be functioning properly or you determine that the problem cannot be corrected in time to maintain the internal temperature within the recommended range, activate the [Emergency Vaccine Retrieval and Storage Plan](#) (see section on Storage and Handling Plans).

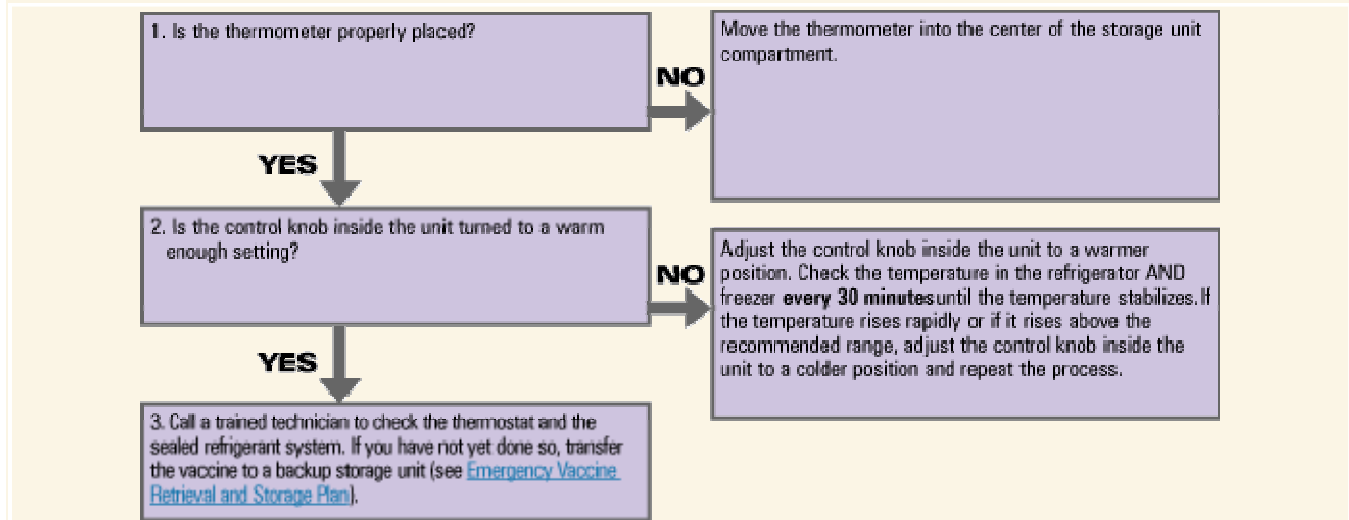

Vaccine Storage Unit is Too Noisy

Warning! Do not allow the vaccine to remain in a nonfunctioning unit for an extended period of time while you attempt to correct the problem. If at any time you are unsure how long the storage unit will not be functioning properly or you determine that the problem cannot be corrected in time to maintain the internal temperature within the recommended range, activate the [Emergency Vaccine Retrieval and Storage Plan](#) (see section on Storage and Handling Plans).

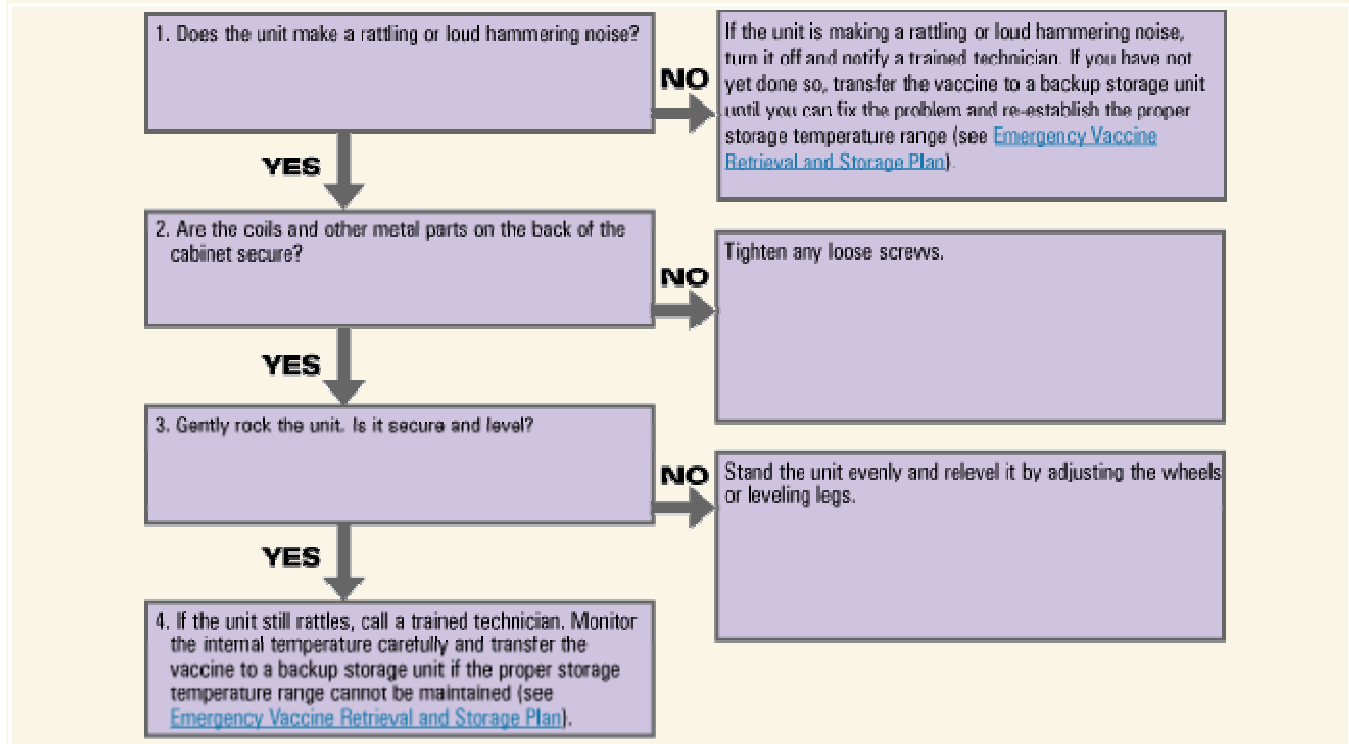

Vaccine Storage Unit Has Stopped

Warning! Do not allow the vaccine to remain in a nonfunctioning unit for an extended period of time while you attempt to correct the problem. If at any time you are unsure how long the storage unit will not be functioning properly or you determine that the problem cannot be corrected in time to maintain the internal temperature within the recommended range, activate the [Emergency Vaccine Retrieval and Storage Plan](#) (see section on Storage and Handling Plans).

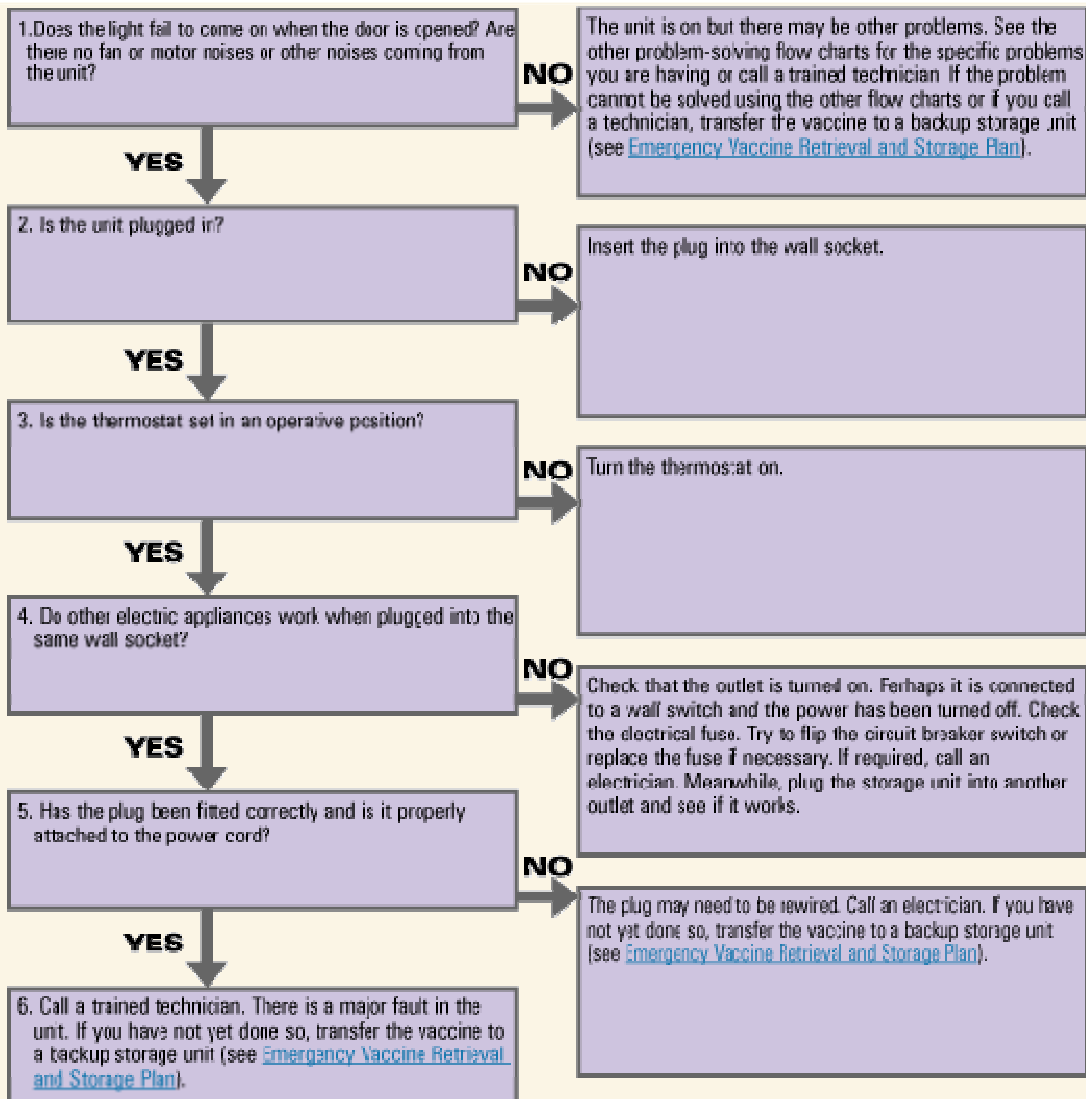

Refrigerator and Freezer Door Problems

Checking the Door Seal

To check that the vaccine storage unit door is sealing properly:

1. Place a thin paper strip against the cabinet front (see Illustration 1).
2. Close the door.
3. Pull the paper strip. If it moves easily or falls away by itself, the door and the rubber-like seal need to be adjusted.
4. Check all the way around the door. Pay particular attention to the corners.

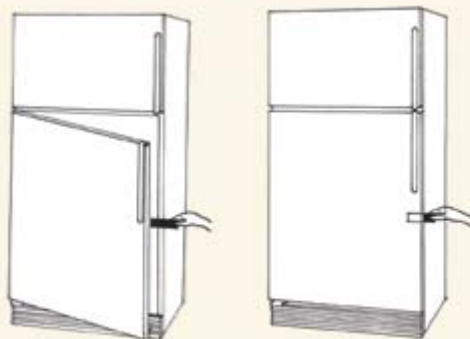

Illustration 1—Checking the door seal.

(Adapted from the *User's Handbook for Compression Refrigerators WHO/EPI/LOG/84/15*)

Adjusting the Door Seal

If you have checked the rubber-like door seal and determined that the door is not closing properly:

1. Loosen the hinge screws on the door slightly and check if the door seals better after the hinges are adjusted (see Illustration 2).
 - a. If the seal on the handle side of the door is loose, move the hinges slightly outward.
 - b. If the seal on the hinge side of the door is loose, move the hinges slightly inward.
2. If the door seal is loose at the corner, it will need to be replaced. Call a trained technician.

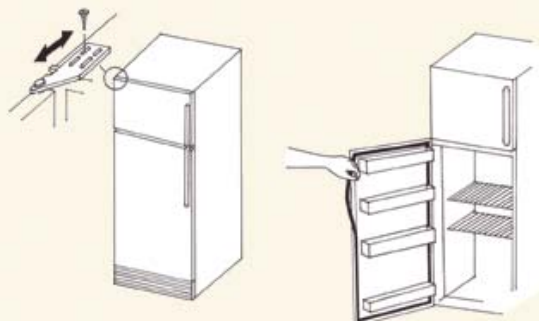

Illustration 2—Adjusting the door seal.

(Adapted from the *User's Handbook for Compression Refrigerators WHO/EPI/LOG/84/15*)

Adjusting Dropped Doors

If the vaccine storage unit door is not level when closed or if it is touching the toe kick plate or another door on the unit, it requires adjustment. Dropped doors can compromise the door seal. To adjust a dropped door:

1. Loosen the upper hinge screws.
2. Make sure the edge of the door is in line with the side of the refrigerator.
3. Hold the door in position and tighten the screws.
 - a. If the lower hinge is worn, the door can be adjusted upward by putting some washers on the hinge. (see Illustration 3)
4. Check the door seal to be sure it is closing properly and tightly.
5. If a dropped door cannot be adjusted, call a trained technician.

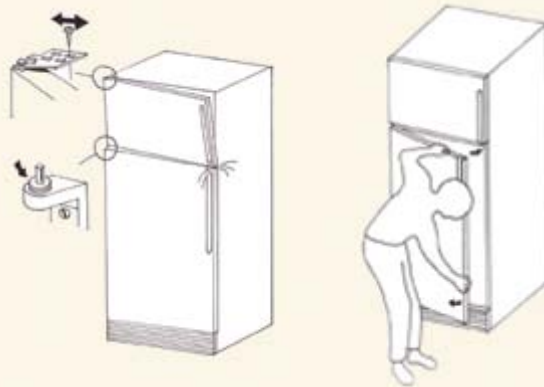

Illustration 3—Adjusting dropped doors.

(Adapted from the *User's Handbook for Compression Refrigerators* WHO/EPI/LOG/84/15)

Thermometer Problems

Checking Thermometer Placement

If the thermometer indicates a temperature outside the recommended range, check that the thermometer is appropriately situated in the center of the storage unit compartment, adjacent to the vaccine. If the thermometer is placed near the coils, walls, floor, or fan, it may indicate colder or warmer temperatures than a thermometer appropriately placed in the center of the compartment where the vaccines should be kept.

Checking If the Thermometer Works

A slight variation in temperature is often seen from one thermometer reading to another, even when the vaccine storage unit thermostat is set at a particular temperature. This is normal. If the thermometer reading does not fluctuate at all over several readings, temporarily remove the thermometer from the storage unit and place it outside the unit at room temperature. Check whether the temperature reading rises. If no change in the temperature reading occurs, the thermometer is faulty and needs to be replaced.

Checking If the Thermometer Is Accurate

If the thermometer appears to be working but there is concern regarding the accuracy of the reading, the standard method of testing the thermometer is to place another certified calibrated thermometer inside the storage unit along with the original one and check the readings on both thermometers.

Power Outages

Advance Preparations

When state officials, local officials, or providers have reasonable cause to believe that a power outage may occur (e.g., adverse weather conditions, natural disasters, or other emergencies

When state officials, local officials, or providers have reasonable cause to believe that a power outage may occur, emergency procedures should be implemented in advance of the event.

that might disrupt power to any office where vaccine is stored) emergency procedures should be implemented **in advance of the event.**

Temperature Considerations

Most refrigerated vaccines will remain stable at elevated temperatures for limited periods of time. The vaccines of most concern are MMR, MMRV, varicella, and zoster vaccines, which are more sensitive to elevated temperatures. Whenever a question arises about the integrity of a vaccine, contact the vaccine manufacturer and the state health department immunization program for guidance (see [Handling Inappropriate Vaccine Storage Conditions \[Light and Temperature\]](#) in this section for details).

Power Outage Procedures

The information below is provided as a guideline. You may use the [Emergency Response Worksheet](#) in the Resources section of this toolkit to help organize your response. Consult your agency, local health department, or state health department immunization program, as appropriate for your situation, for any special instructions or forms. If there is an ongoing power outage, take the following steps:

1. Do not allow the vaccine to remain in a nonfunctioning unit for an extended period of time. If at any time you are unsure how long the power to the vaccine storage unit will be interrupted or you determine that the power will not be restored in time to maintain the internal temperature within the recommended range, activate the [Emergency Vaccine Retrieval and Storage Plan](#) (see section on Storage and Handling Plans) and **disregard** the following steps.
2. If you are **certain** the power will be restored before the vaccine storage unit temperature rises above the recommended range, take the following steps:
 - a. Do not open the refrigerator or freezer door until the power is restored.
 - b. Continue to monitor the temperatures inside the vaccine storage unit.
 - i. Some thermometers allow temperature monitoring without opening the storage unit doors. In this case, record the room temperature and the temperature(s) inside the unit(s) at the time the problem is discovered, as well as the minimum

		and maximum temperatures reached inside the unit(s) during the power outage.
	ii.	If these types of thermometers are not being used, do not open the door(s) to check the temperature(s) during the power outage. Instead, record the room temperature, the duration of the power outage, and the temperature(s) inside the unit(s) as soon as possible after the power is restored. This will provide data on the maximum temperature and maximum duration of exposure to elevated temperatures.
	c.	Record the room temperature and the temperatures inside the vaccine storage units as soon as possible after power has been restored . Record the length of time the power has been off and the maximum temperature observed.
	d.	If the temperature inside the refrigerator has exceeded the recommended range of 35° to 46°F (2° to 8°C) or if the temperature inside the freezer has risen above 5°F (-15°C), record the duration of inappropriate temperature exposure and follow the procedures for Handling Inappropriate Vaccine Storage Conditions [Light and Temperature] in this section.

The Center for Biologics Evaluation and Research (CBER) at the Food and Drug Administration (FDA) offers general guidance concerning the storage and use of temperature-sensitive biological products that have been involved in a temporary electrical power failure or flood conditions (see [Emergency Management Internet Resources](#) in the Resources section of this toolkit).

Other Imminent Emergencies

When state officials, local officials, or providers have reasonable cause to believe that weather conditions, natural disasters, or other imminent emergencies might disrupt power or flood any office where vaccine is stored, emergency procedures should be implemented **in advance of the event** (see [Emergency Vaccine Retrieval and Storage Plan](#) in the Storage and Handling Plans section).